

U 4.400

Ersatzteilliste
 Spare parts list
 Liste de pièces de rechange
 Listino pezzi di ricambio
 Lista de piezas de recambio
 Reserveonderdelenlijst
 Reservdelistsite
 Reservdelistsita

Reservdelistsite
 Varaosaluettelo
 Wykaz części zamiennych
 Seznam náhradních dílů
 Tartalékalkatrész lista
 Κατάλογος ανταλλακτικών
 Yedek parça listesi
 Перечень запасных частей
 备用零件目录
 スペアパーツリスト

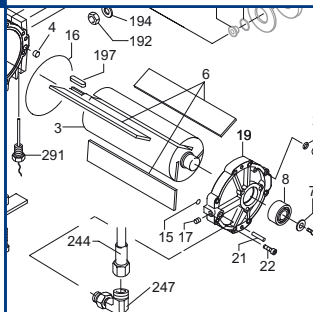

SERVICE

BECKER
D-42279 Wuppertal
www.becker-international.com

No. **D** year XXXX

type **U 4.400-XX**

frequency XXXX Hz

speed XXXX min⁻¹

power required XXXX kW

inlet capacity XXXX m³/h

pressure + XXXX mbar

vacuum - XXXX mbar

Made in Germany

Index Variante

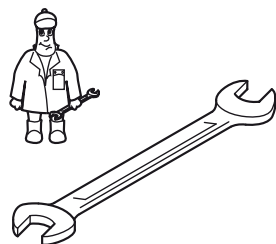

Pos.	Menge ²⁾ Quantity Quantité Quantità Cantidad	Bestell-Nr. Ident No. No. Identification No. Identificazione No. de pedido	Bezeichnung Description Designation Designazione Descripción
□	1	549000 26700	Dichtungssatz, Complete set of seals, Jeu de joints, Kit di guarnizioni, Junta Completa
6	SATZ/KIT	900580 00003	Schieber, Rotor Vane, Palette, Empujador
89	2	965410 00000	Luftentölelement, Oil separating element, Element separation huile, Cartuccia sepa-ratore olio, Elemento de desaceitar de aire
94	3	506000 12900	Grobabscheider, Coarse separator, Separateur a gros, Separatore grossolano, Separador de solidos gruesos

²⁾ erforderliche Bestellmenge / necessary order quantity / quantité nécessaire / quantità di ordinazione necessari / cantidad necesario

Wartung
Maintenance
Entretien
Manutenzione
Mantenimiento



SERVICE

www.becker-international.com

Sales and service network

U 4.400

Standard



Variante





U 4.400/XX

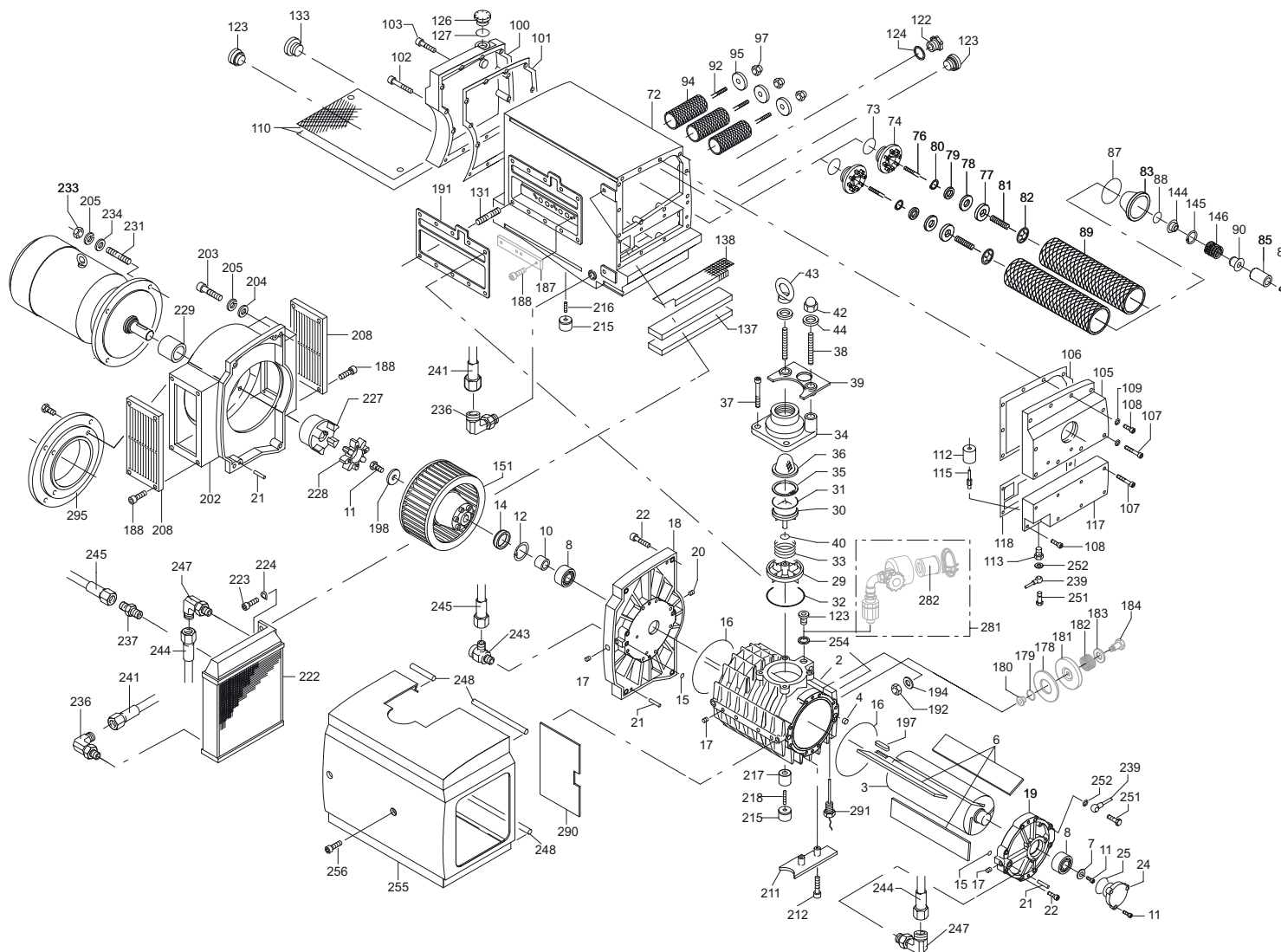

- ①
U 4.400 F/K
- ②
U 4.400 SA/K-25 + F/K-25
- ③ ④
U 4.400 SA/K-25 + F/K-25
- ⑤ ⑥
U 4.400 SA/K-51 + F/K-51

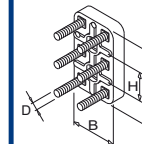
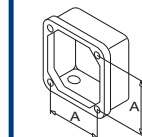
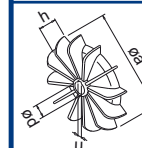
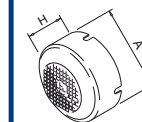
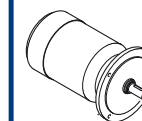

SERVICE ?





D INDEX	Pos.	Bestell Nr.	Beschreibung	
U 4.400	□	549000 26700	DICHTUNGSSATZ ¹⁾	
	2	000101 26600	GEHÄUSE	
	3	020001 26600	KOLBEN	
	4	912818 00000	VERSCHLUSS-SCHRAUBE	
	6	900580 00003	KUNSTSTOFFSCHIEBER (SATZ) ²⁾	
	7	016803 26600	SCHEIBE	
	8	906605 00000	NADELLAGER	
	9	906600 00700	INNENRING	
	10	906600 00800	INNENRING	
	11	945270 00000	INNENSECHSKANTSCHRAUBE	
	12	948209 10000	SEEGER-RING	
	14	906530 00000	WELLENDICHRING	
	17	912871 00000	VERSCHLUSS-SCHRAUBE	
	18	000801 26600	SEITENDECKEL	
	19	000701 26600	SEITENDECKEL	
20	912820 00000	VERSCHLUSS-SCHRAUBE		
21	948744 00000	KERBSTIFT		
22	945390 00000	INNENSECHSKANTSCHRAUBE		
24	005604 26600	DECKEL		
29	029100 26600	VENTILTRÄGER		
30	033904 26600	VENTILPLATTE		
33	928603 10000	DRUCKFEDER		
34	007800 26600	GEWINDEFLENSCH		
35	948225 00000	SICHERUNGSRING		
36	008000 26600	SIEB		
37	945351 00000	INNENSECHSKANTSCHRAUBE		
38	946967 00000	STIFTSCHRAUBE		
39	003700 26600	DECKEL		
42	947410 00000	HUTMUTTER		
43	951604 00000	RINGMUTTER		
44	947514 00000	U-SCHEIBE		
72	002402 26600	ÖLABSCHEIDERGEHÄUSE		
74	022800 26600	FILTERTRÄGER		
76	951049 02000	STIFTSCHRAUBE		
77	033901 26600	VENTILPLATTE		
78	030700 26600	VENTILSCHEIBE		
79	917551 04000	PASS-SCHEIBE		
80	948128 04000	SEEGERRING		
81	928602 80000	DRUCKFEDER		
82	950185 00000	KLEMMSCHEIBE		
83	005603 26600	DECKEL		
84	945637 00000	GEWINDESTIFT		
85	068010 26600	DISTANZSTÜCK		
89	965410 00000	LUFTENTÖLELEMENT (2x) ²⁾		
90	968008 26600	DISTANZSTÜCK		
92	951041 02000	STIFTSCHRAUBE		
94	506000 12900	GROBABSCHIEDER (3x) ²⁾		
95	905600 21900	DECKEL		
97	947402 00000	HUTMUTTER		
100	002504 26600	ÖLABSCHEIDERDECKEL		
102	945391 00000	INNENSECHSKANTSCHRAUBE		
103	945392 00000	INNENSECHSKANTSCHRAUBE		
105	002500 26600	ÖLABSCHEIDERDECKEL		
107	945353 00000	INNENSECHSKANTSCHRAUBE		
108	945350 00000	INNENSECHSKANTSCHRAUBE		
110	008003 26600	SIEB		
112	867800 99559	SCHWIMMER		
113	912300 00000	ANSCHLUSS-SCHRAUBE		
115	003300 10700	DÜSE		

D INDEX	Pos.	Bestell Nr.	Beschreibung	
	117	002501 26600	ÖLABSCHEIDERDECKEL	
	122	907309 00000	ÖLSCHAUGLAS	
	123	951220 00100	VERSCHLUSS-SCHRAUBE	
	126	916800 10000	SCHRAUBDECKEL	
	131	946945 00000	STIFTSCHRAUBE	
	133	951221 00100	VERSCHLUSS-SCHRAUBE	
	138	064600 26600	FILTERMATTE	
	139	008002 26600	SIEB	
	144	068006 26600	DISTANZSTÜCK	
	145	948215 00000	SEEGER-RING	
	146	928603 30000	DRUCKFEDER	
	151	502301 26600	KUPPLUNGSHÄLFTE MIT VENTILATOR	
	192	947107 00000	SECHSKANTMUTTER	
	194	948516 00000	FEDERRING	
	197	947820 00000	PASSFEDER	
	198	016803 26600	SCHEIBE	
	199	945270 00000	SCHRAUBE	
	202	053200 26600	LATERNE	
	203	945388 00000	INNENSECHSKANTSCHRAUBE	
	204	947515 00000	U-SCHEIBE	
	205	948511 00000	FEDERRING	
	206	948744 00000	KERBSTIFT	
	208	003702 26600	DECKEL	
	211	003701 26600	DECKEL	
	212	945333 00000	INNENSECHSKANTSCHRAUBE	
	215	741341 00000	GUMMIPUFFER	
	216	945633 00000	GEWINDESTIFT	
	217	068001 26600	DISTANZSTÜCK	
	218	946811 00000	STIFTSCHRAUBE	
	222	560200 26600	KÜHLER KOMPLETT	
	223	945348 00000	INNENSECHSKANTSCHRAUBE	
	224	951710 00000	FEDERSCHEIBE	
	227	902102 26600	MOTORKUPPLUNG	
	228	902227 00000	KUPPLUNGSSCHEIBE	
	229	068004 26600	DISTANZSTÜCK	
	231	946962 00000	STIFTSCHRAUBE	
	233	947109 00000	SECHSKANTMUTTER	
	234	947509 00000	U-SCHEIBE	
	236	961710 00000	WINKEL	
	237	972308 00000	ERMETO-VERSCHRAUBUNG	
	239	512200 26600	ÖLRÜCKFÜHRLEITUNG	
	241	012204 26700	LEITUNG	
	243	761703 01000	ERMETO-VERSCHRAUBUNG	
	244	012206 26600	LEITUNG	
	245	012207 26600	LEITUNG	
	247	961709 00000	WINKEL	
	248	064101 57000	PROFILGUMMI	
	251	009400 19000	KUGELSTÜCKSCHRAUBE	
	255	518300 26600	HAUBE	
	256	945389 00000	INNENSECHSKANTSCHRAUBE	
	281	768704 99626	GASBALLASTVENTIL - OPTIONAL	
	282	740001 05000	FILTERPATRONE, F10	
	290	060900 26600	DÄMPFUNGSMATTE	
	291	943400 90000	TEMPERATURFÜHLER	
		960009 00200	BECKER LUBE M 100 (MINERALÖL) - 5L	
		960016 00200	BECKER LUBE S 100 (SYNTHETIKÖL) - 5L	
		960023 00200	BECKER LUBE SL 100 (LEBENSMITTELBEREICH) - 5L	

¹⁾ Dichtungssatz - 549000 26700 - Pos.: 15, 16, 25, 31, 32, 40, 73, 87, 88, 101, 106, 109, 118, 124, 127, 141, 185, 191, 252, 254

²⁾ erforderliche Bestellmenge / Wartung

D INDEX	Pos.	Ident No.	Description	
U 4.400	□	549000 26700	SET OF SEALS ¹⁾	
	2	000101 26600	PUMP BODY	
	3	020001 26600	ROTOR	
	4	912818 00000	SCREWED SEALING PLUG	
	6	900580 00003	PLASTIC VANES (KIT) ²⁾	
	7	016803 26600	WASHER	
	8	906605 00000	NEEDLE BEARING	
	9	906600 00700	INTERIOR RING	
	10	906600 00800	INTERIOR RING	
	11	945270 00000	SOCKET HEAD SCREW	
	12	948209 10000	SEEGER-LOCKRING	
	14	906530 00000	SHAFT SEALING RING	
	17	912871 00000	LOCKING SCREW	
	18	000801 26600	LID	
	19	000701 26600	LID	
20	912820 00000	LOCKING SCREW		
21	948744 00000	GROOVED PIN		
22	945390 00000	SOCKET HEAD SCREW		
24	005604 26600	COVER		
29	029100 26600	VALVE SUPPORT		
30	033904 26600	VALVE PLATE		
33	928603 10000	PRESSURE SPRING		
34	007800 26600	FLANGE		
35	948225 00000	LOCKING RING		
36	008000 26600	SIEVE		
37	945351 00000	SOCKET HEAD SCREW		
38	946967 00000	STUD		
39	003700 26600	COVER		
42	947410 00000	CAP NUT		
43	951604 00000	RING UNIT		
44	947514 00000	WASHER		
72	002402 26600	HOUSING FOR OIL SEPARATION		
74	022800 26600	FILTER HOLDER		
76	951049 02000	STUD		
77	033901 26600	VALVE PLATE		
78	030700 26600	VALVE WASHER		
79	917551 04000	DISTANCE DISC		
80	948128 04000	SEEGER LOCKRING		
81	928602 80000	PRESSURE SPRING		
82	950185 00000	SEEGER-LOCKRING		
83	005603 26600	COVER		
84	945637 00000	THREADED PIN		
85	068010 26600	SPACER BLOCK		
89	965410 00000	OIL SEPARATION ELEMENT (2x) ²⁾		
90	968008 26600	SPACER BLOCK		
92	951041 02000	STUD		
94	506000 12900	COARSE SEPARATOR (3x) ²⁾		
95	905600 21900	COVER		
97	947402 00000	CAP NUT		
100	002504 26600	OIL SEPARATOR COVER		
102	945391 00000	SOCKET HEAD SCREW		
103	945392 00000	SOCKET HEAD SCREW		
105	002500 26600	OIL SEPARATOR COVER		
107	945353 00000	SOCKET HEAD SCREW		
108	945350 00000	SOCKET HEAD SCREW		
110	008003 26600	SIEVE		
112	867800 99559	FLOAT		
113	912300 00000	CONNECTING SCREW		
115	003300 10700	NOZZLE		

D INDEX	Pos.	Ident No.	Description	
	117	002501 26600	OIL SEPARATOR COVER	
	122	907309 00000	OIL SIGHT GLASS	
	123	951220 00100	LOCKING SCREW	
	126	916800 10000	COVER	
	131	946945 00000	STUD	
	133	951221 00100	LOCKING SCREW	
	138	064600 26600	FILTER INSERT	
	139	008002 26600	SIEVE	
	144	068006 26600	SPACER BLOCK	
	145	948215 00000	SEEGER-LOCKRING	
	146	928603 30000	PRESSURE SPRING	
	151	502301 26600	COUPLING WITH FAN	
	192	947107 00000	HEX. NUT	
	194	948516 00000	SPRING WASHER	
	197	947820 00000	KEY	
	198	016803 26600	WASHER	
	199	945270 00000	SCREW	
	202	053200 26600	CONNECTION FLANGE	
	203	945388 00000	SOCKET HEAD SCREW	
	204	947515 00000	WASHER	
	205	948511 00000	SPRING WASHER	
	206	948744 00000	GROOVED PIN	
	208	003702 26600	COVER	
	211	003701 26600	COVER	
	212	945333 00000	SOCKET HEAD SCREW	
	215	741341 00000	RUBBER BUFFER	
	216	945633 00000	THREADED PIN	
	217	068001 26600	SPACING COLLAR	
	218	946811 00000	STUD	
	222	560200 26600	COOLER	
	223	945348 00000	SOCKET HEAD SCREW	
	224	951710 00000	SPRING DISC	
	227	902102 26600	COUPLING MOTOR SIDE	
	228	902227 00000	COUPLING DISC	
	229	068004 26600	SPACER BLOCK	
	231	946962 00000	STUD	
	233	947109 00000	HEX. NUT	
	234	947509 00000	WASHER	
	236	961710 00000	ELBOW	
	237	972308 00000	THREADED JOINT	
	239	512200 26600	OIL RETURN PIPE	
	241	012204 26700	PIPE	
	243	761703 01000	THREADED JOINT	
	244	012206 26600	PIPE	
	245	012207 26600	PIPE	
	247	961709 00000	ELBOW	
	248	064101 57000	RUBBER PROFIL	
	251	009400 19000	HOLLOW HOLDING SCREW	
	255	518300 26600	PROTECTING HOOD	
	256	945389 00000	SOCKET HEAD SCREW	
	281	768704 99626	GAS BALLAST VALVE - OPTIONAL	
	282	740001 05000	FILTER CARTRIDGE, F10	
	290	060900 26600	SILENCER	
	291	943400 90000	TEMPERATURE PROBE	
		960009 00200	BECKER LUBE M 100 (MINERAL OIL) - 5L	
		960016 00200	BECKER LUBE S 100 (SYNTHETIC OIL) - 5L	
		960023 00200	BECKER LUBE SL 100 (FOOD SECTOR) - 5L	

¹⁾ Set of seals - 549000 26700 - Pos.: 15, 16, 25, 31, 32, 40, 73, 87, 88, 101, 106, 109, 118, 124, 127, 141, 185, 191, 252, 254

²⁾ necessary order quantity / maintenance

D INDICE	Pos.	No. Identification	Designation	FR	
U 4.400	□	549000 26700	JEU DE JOINTS ¹⁾		
	2	000101 26600	CARCASSE		
	3	020001 26600	PISTON		
	4	912818 00000	VIS DE FERMETURE		
	6	900580 00003	PALETTE ON PLASTIQUE (KIT) ²⁾		
	7	016803 26600	RONDELLE		
	8	906605 00000	ROULEMENT À AIGUILLES		
	9	906600 00700	BAGUE INTERIEURE		
	10	906600 00800	BAGUE INTERIEURE		
	11	945270 00000	VIS HEXAGONALE INTERNE		
	12	948209 10000	BAGUE DE SURETE		
	14	906530 00000	BAGUE D'ETANCHEITE		
	17	912871 00000	BOUCHON		
	18	000801 26600	COUVERCLE		
	19	000701 26600	COUVERCLE		
20	912820 00000	BOUCHON			
21	948744 00000	GOUPILLE CYLINDRIQUE			
22	945390 00000	VIS HEXAGONALE INTERNE			
24	005604 26600	COUVERCLE			
29	029100 26600	SUPPORT DE SOUPE			
30	033904 26600	CLAPET			
33	928603 10000	RESSORT DE PRESSION			
34	007800 26600	BRIDE			
35	948225 00000	BAGUE DE SURETE			
36	008000 26600	FILTRE			
37	945351 00000	VIS HEXAGONALE INTERNE			
38	946967 00000	TOURILLON			
39	003700 26600	COUVERCLE			
42	947410 00000	ECROU BORGNE			
43	951604 00000	ECROU A ANNEAU			
44	947514 00000	RONDELLE			
72	002402 26600	CARCASSE POUR SEPARATION D'HUILE			
74	022800 26600	SUPPORT FILTRE			
76	951049 02000	TOURILLON			
77	033901 26600	CLAPET			
78	030700 26600	DISQUE DE SOUPE			
79	917551 04000	DISQUE DE TOLERANCE			
80	948128 04000	BAGUE DE SURETE			
81	928602 80000	RESSORT DE PRESSION			
82	950185 00000	BAGUE DE SURETE			
83	005603 26600	COUVERCLE			
84	945637 00000	GOUPILLE FILETEE			
85	068010 26600	PIECE D'ECARTEMENT			
89	965410 00000	ELEMENT SEPARATION HUILE (2x) ²⁾			
90	968008 26600	PIECE D'ECARTEMENT			
92	951041 02000	TOURILLON			
94	506000 12900	SEPARATEUR A GROS (3x) ²⁾			
95	905600 21900	COUVERCLE			
97	947402 00000	ÉCROU BORGNE			
100	002504 26600	COUVERCLE SEPARATEUR D'HUILE			
102	945391 00000	VIS HEXAGONALE INTERNE			
103	945392 00000	VIS HEXAGONALE INTERNE			
105	002500 26600	COUVERCLE DU SEPARATEUR D'HUILE			
107	945353 00000	VIS HEXAGONALE INTERNE			
108	945350 00000	VIS HEXAGONALE INTERNE			
110	008003 26600	TAMIS			
112	867800 99559	PIED CAOUTCHOUC			
113	912300 00000	VIS DE RACCORD			
115	003300 10700	GICLÉUR			

D INDICE	Pos.	No. Identification	Designation	FR	
	117	002501 26600	COUVERCLE DU SEPARATEUR D'HUILE		
	122	907309 00000	VERRE REGARD		
	123	951220 00100	BOUCHON		
	126	916800 10000	COUVERCLE		
	131	946945 00000	PRISONNIER		
	133	951221 00100	BOUCHON		
	138	064600 26600	FILTRE DE RECHANGE		
	139	008002 26600	FILTRE		
	144	068006 26600	PIECE D'ECARTEMENT		
	145	948215 00000	BAGUE DE SURETE		
	146	928603 30000	RESSORT DE PRESSION		
	151	502301 26600	ACCOUPLLEMENT AVEC VENTILATEUR		
	192	947107 00000	ECROU A 6 PANS		
	194	948516 00000	ANNEAU RESSORT		
	197	947820 00000	CLAVETTE		
	198	016803 26600	RONDELLE		
	199	945270 00000	VIS		
	202	053200 26600	BRIDE DE RACCORDEMENT		
	203	945388 00000	VIS HEXAGONALE INTERNE		
	204	947515 00000	RONDELLE		
	205	948511 00000	ANNEAU RESSORT		
	206	948744 00000	GOUPILLE À ENCOCHES		
	208	003702 26600	COUVERCLE		
	211	003701 26600	COUVERCLE		
	212	945333 00000	VIS HEXAGONALE INTERNE		
	215	741341 00000	AMORTISSEUR EN CAOUTCHOUC		
	216	945633 00000	GOUPILLE FILETEE		
	217	068001 26600	DONILLE D'ECARMENT		
	218	946811 00000	TOURILLON		
	222	560200 26600	REFROIDISSEUR		
	223	945348 00000	VIS HEXAGONALE INTERNE		
	224	951710 00000	DISQUE DE RESSORT		
	227	902102 26600	ACCOUPLLEMENT MOTEUR		
	228	902227 00000	DISQUE D'ACCOUPLLEMENT		
	229	068004 26600	PIECE D'ECARTEMENT		
	231	946962 00000	TOURILLON		
	233	947109 00000	ECROU A 6 PANS		
	234	947509 00000	RONDELLE		
	236	961710 00000	COUDES		
	237	972308 00000	RACCORD A VIS		
	239	512200 26600	TUYAU D'HUILE		
	241	012204 26700	TUYAU		
	243	761703 01000	RACCORD A VIS		
	244	012206 26600	TUYAU		
	245	012207 26600	TUYAU		
	247	961709 00000	COUDES		
	248	064101 57000	CAOUTCHOUC PROFILE		
	251	009400 19000	VIS CREUSE DE FIXATION		
	255	518300 26600	CARTER PROTECTEUR		
	256	945389 00000	VIS HEXAGONALE INTERNE		
	281	768704 99626	L'ESTE D'AIR - EN OPTION		
	282	740001 05000	CARTOUCHE FILTRANTE, F10		
	290	060900 26600	AMORTISSEUR		
	291	943400 90000	PALPEUR DE TEMPÉRATURE		
		960009 00200	BECKER LUBE M 100 (HUILE MINÉRALE) - 5L		
		960016 00200	BECKER LUBE S 100 (L'HUILE SYNTHÉTIQUE) - 5L		
		960023 00200	BECKER LUBE SL 100 (SECTEUR DE L'ALIMENTATION) - 5L		

¹⁾ Jeu de joints - 549000 26700 - Pos.: 15, 16, 25, 31, 32, 40, 73, 87, 88, 101, 106, 109, 118, 124, 127, 141, 185, 191, 252, 254

²⁾ quantité nécessaire / entretien

D INDICE	Pos.	No. Identificazione	Designazione
U 4.400	□	549000 26700	SERIE DI GUARNIZIONE ¹⁾
	2	000101 26600	CARASSA
	3	020001 26600	ROTORE
	4	912818 00000	TAPPO A VITE
	6	900580 00003	PALETTA IN PLASTICA (KIT) ²⁾
	7	016803 26600	RONDELLA
	8	906605 00000	CUSCINETTO AD AGHI
	9	906600 00700	ANELLO INTERNO
	10	906600 00800	ANELLO INTERNO
	11	945270 00000	VITE ESAGONALE INTERNA
	12	948209 10000	ANNELLO DI SICUREZZA
	14	906530 00000	ANELLO DI TENUTA
	17	912871 00000	VITE DI CHIUSURA
	18	000801 26600	COPERCHIO
	19	000701 26600	COPERCHIO
	20	912820 00000	TAPPO A VITE
	21	948744 00000	PERNO
	22	945390 00000	VITE ESAGONALE INTERNA
	24	005604 26600	COPERCHIO
	29	029100 26600	SEDE DELLA VALVOLA
	30	033904 26600	SUPPORTO VALVOLA
	33	928603 10000	MOLLA DELLA PRESSIONE
	34	007800 26600	FLANGIA
	35	948225 00000	ANELLO DI SICUREZZA
	36	008000 26600	FILTRO
	37	945351 00000	VITE ESAGONALE INTERNA
	38	946967 00000	L'ASTA A VITE
	39	003700 26600	COPERCHIO
	42	947410 00000	DADO CIECO
	43	951604 00000	GOLFARE CON FORO FILETTATO
	44	947514 00000	RONDELLA
	72	002402 26600	CARASSE SEPARAZIONE OLIO
	74	022800 26600	SUPPORTO FILTRO
	76	951049 02000	L'ASTA A VITE
	77	033901 26600	SUPPORTO VALVOLA
	78	030700 26600	DISCO DELLA VALVOLA
	79	917551 04000	DISCO A DISTANZA
	80	948128 04000	ANNELLO DI SICUREZZA
	81	928602 80000	MOLLA DELLA PRESSIONE
	82	950185 00000	ANELLO DI SICUREZZA
	83	005603 26600	COPERCHIO
	84	945637 00000	SPINA FILETTATURA
	85	068010 26600	DISTANZIATORE
	89	965410 00000	CARTUCCIA SEPARATORE OLIO (2x) ²⁾
	90	968008 26600	DISTANZIATORE
	92	951041 02000	L'ASTA A VITE
	94	506000 12900	SEPARATORE GROSSOLANO (3x) ²⁾
	95	905600 21900	COPERCHIO
	97	947402 00000	DADO CIECO
	100	002504 26600	COPERCHIO SEPARATOR OLIO
	102	945391 00000	VITE ESAGONALE INTERNA
	103	945392 00000	VITE ESAGONALE INTERNA
	105	002500 26600	COPERCHIO SEPARATORE OLIO
	107	945353 00000	VITE ESAGONALE INTERNA
	108	945350 00000	VITE ESAGONALE INTERNA
	110	008003 26600	STACCIO
	112	867800 99559	GALLEGGIANTE
	113	912300 00000	ATTACO FILETTATO
	115	003300 10700	UGELLO

D INDICE	Pos.	No. Identificazione	Designazione
	117	002501 26600	COPERCHIO SEPARATORE OLIO
	122	907309 00000	SPIA LIVELLO OLIO
	123	951220 00100	VITE DI CHIUSURA
	126	916800 10000	COPERCHIO
	131	946945 00000	L'ASTA A VITE
	133	951221 00100	VITE DI CHIUSURA
	138	064600 26600	FILTRO DI RICAMBIO
	139	008002 26600	FILTRO
	144	068006 26600	DISTANZIATORE
	145	948215 00000	ANNELLO DI SICUREZZA
	146	928603 30000	MOLLA DELLA PRESSIONE
	151	502301 26600	GIUNTO CON VENTILATORE
	192	947107 00000	DADO ESAGONALE
	194	948516 00000	RONDELLA GROWER
	197	947820 00000	CHIAVETTA
	198	016803 26600	RONDELLA
	199	945270 00000	VITE
	202	053200 26600	FLANGIA DI RACCORDE
	203	945388 00000	VITE ESAGONALE INTERNA
	204	947515 00000	RONDELLA PIANA
	205	948511 00000	RONDELLA GROWER
	206	948744 00000	SPINA SCANALATA
	208	003702 26600	COPERCHIO
	211	003701 26600	COPERCHIO
	212	945333 00000	VITE ESAGONALE INTERNA
	215	741341 00000	AMMORTIZZATORE IN GOMMA
	216	945633 00000	VITE SENZA TESTA
	217	068001 26600	BOCCOLA DISTANZIATRICE
	218	946811 00000	VITE PRIGIONIERA
	222	560200 26600	RAFFREDDATORE
	223	945348 00000	VITE ESAGONALE INTERNA
	224	951710 00000	DISCO A MOLLA
	227	902102 26600	GIUNTO MOTORE
	228	902227 00000	DISCO GIUNTO
	229	068004 26600	BOCCOLA DISTANZIATRICE
	231	946962 00000	VITE PRIGIONIERA
	233	947109 00000	DADO ESAGONALE
	234	947509 00000	RONDELLA PIANA
	236	961710 00000	GOMITO
	237	972308 00000	RACCORDO A VITE
	239	512200 26600	CONDOTTO OLIO
	241	012204 26700	CONDOTTO
	243	761703 01000	RACCORDO A VITE
	244	012206 26600	CONDOTTO
	245	012207 26600	CONDOTTO
	247	961709 00000	GOMITO
	248	064101 57000	GOMMA PROFILOTO
	251	009400 19000	VITE PASSAGGIO OLIO
	255	518300 26600	CARTER DI PROTEZIONE
	256	945389 00000	VITE ESAGONALE INTERNA
	281	768704 99626	VALVOLA DI ZAVORATRICE - OPZIONALE
	282	740001 05000	CARTUCCIA FILTRO, F10
	290	060900 26600	SILENZIATORE
	291	943400 90000	PALPATORE DI TEMPERATURA
		960009 00200	BECKER LUBE M 100 (OLIO MINERALE) - 5L
		960016 00200	BECKER LUBE S 100 (OLIO SINTETICO) - 5L
		960023 00200	BECKER LUBE SL 100 (SETTORE ALIMENTARE) - 5L

¹⁾ Serie di guarnizione - 549000 26700 - Pos.: 15, 16, 25, 31, 32, 40, 73, 87, 88, 101, 106, 109, 118, 124, 127, 141, 185, 191, 252, 254

²⁾ quantità di ordinazione necessari / manutenzione

D INDICE	Pos.	No. De pedido	Descripción	
U 4.400	■	549000 26700	JUNTA COMPLETA ¹⁾	
	2	000101 26600	CARCASA	
	3	020001 26600	ÉMBOLO	
	4	912818 00000	TORNILLO DE CIERRE	
	6	900580 00003	DESPLAZADOR DE PLÁSTICO (KIT) ²⁾	
	7	016803 26600	ARANDELA	
	8	906605 00000	COJINETE DE AGUJAS	
	9	906600 00700	ANILLO INTERIOR	
	10	906600 00800	ANILLO INTERIOR	
	11	945270 00000	TORNILLO HEXAGONAL INTERIOR	
	12	948209 10000	ANILLO DE RETENCIÓN	
	14	906530 00000	ANILLO DE JUNTA DE ÁRBOL	
	17	912871 00000	TORNILLO DE CIERRE	
	18	000801 26600	TAPA LATERAL	
	19	000701 26600	TAPA LATERAL	
	20	912820 00000	TORNILLO DE CIERRE	
	21	948744 00000	PASADOR CILÍNDRICO ESTRIADO	
	22	945390 00000	TORNILLO HEXAGONAL INTERIOR	
	24	005604 26600	TAPA	
	29	029100 26600	SOPORTE DE VÁLVULA	
	30	033904 26600	PLACA DE VÁLVULA	
	33	928603 10000	MUELLE DE COMPRESIÓN	
	34	007800 26600	BRIDA ROSCADA	
	35	948225 00000	ANILLO DE ASEGURAMIENTO	
	36	008000 26600	CRIBA	
	37	945351 00000	TORNILLO HEXAGONAL INTERIOR	
	38	946967 00000	ESPÁRRAGO	
	39	003700 26600	TAPA	
	42	947410 00000	TUERCA DE CAPERUZA	
	43	951604 00000	TUERCA DE CÁNCAMO	
	44	947514 00000	ARANDELA	
	72	002402 26600	CARCASA DE SEPARADOR DE ACEITE	
	74	022800 26600	SOPORTE DE FILTRO	
	76	951049 02000	ESPÁRRAGO	
	77	033901 26600	PLACA DE VÁLVULA	
	78	030700 26600	DISCO DE VÁLVULA	
	79	917551 04000	ARANDELA DE AJUSTE	
	80	948128 04000	ANILLO DE RETENCIÓN	
	81	928602 80000	MUELLE DE COMPRESIÓN	
	82	950185 00000	ABRAZADERA DE APRIETE	
	83	005603 26600	TAPA	
	84	945637 00000	VARILLA ROSCADA	
	85	068010 26600	PIEZA DISTANCIADORA	
	89	965410 00000	ELEMENTO DE DESACEITAR DE AIRE (2x) ²⁾	
	90	968008 26600	PIEZA DISTANCIADORA	
	92	951041 02000	ESPÁRRAGO	
	94	506000 12900	SEPARADOR DE SOLIDOS GRUESOS (3x) ²⁾	
	95	905600 21900	TAPA	
	97	947402 00000	TUERCA CIEGA	
	100	002504 26600	TAPA DE SEPARADOR DE ACEITE	
	102	945391 00000	TORNILLO HEXAGONAL INTERIOR	
	103	945392 00000	TORNILLO HEXAGONAL INTERIOR	
	105	002500 26600	TAPA DE SEPARADOR DE ACEITE	
	107	945353 00000	TORNILLO HEXAGONAL INTERIOR	
	108	945350 00000	TORNILLO HEXAGONAL INTERIOR	
	110	008003 26600	CRIBA	
	112	867800 99559	FLOTADOR	
	113	912300 00000	TORNILLO DE EMPALME	
	115	003300 10700	TOBERA	

D INDICE	Pos.	No. De pedido	Descripción	
	117	002501 26600	TAPA DE SEPARADOR DE ACEITE	
	122	907309 00000	CRISTAL MIRILLA DE ACEITE	
	123	951220 00100	TORNILLO DE CIERRE	
	126	916800 10000	TAPA ROSCADA	
	131	946945 00000	ESPÁRRAGO	
	133	951221 00100	TORNILLO DE CIERRE	
	138	064600 26600	ESTERA DE FILTRO	
	139	008002 26600	CRIBA	
	144	068006 26600	PIEZA DISTANCIADORA	
	145	948215 00000	ANILLO DE RETENCIÓN	
	146	928603 30000	MUELLE DE COMPRESIÓN	
	151	502301 26600	MITAD DE ACOPLAMIENTO CON VENTILADOR	
	192	947107 00000	TUERCA HEXAGONAL	
	194	948516 00000	ARANDELA DE MUELLE	
	197	947820 00000	LENGÜETA DE AJUSTE	
	198	016803 26600	ARANDELA	
	199	945270 00000	TORNILLO	
	202	053200 26600	FAROL	
	203	945388 00000	TORNILLO HEXAGONAL INTERIOR	
	204	947515 00000	ARANDELA	
	205	948511 00000	ARANDELA DE MUELLE	
	206	948744 00000	PASADOR ESTRIADO	
	208	003702 26600	TAPA	
	211	003701 26600	TAPA	
	212	945333 00000	TORNILLO HEXAGONAL INTERIOR	
	215	741341 00000	AMORTIGUADOR DE GOMA	
	216	945633 00000	VARILLA ROSCADA	
	217	068001 26600	PIEZA DISTANCIADORA	
	218	946811 00000	ESPÁRRAGO	
	222	560200 26600	REFRIGERADOR COMPLETO	
	223	945348 00000	TORNILLO HEXAGONAL INTERIOR	
	224	951710 00000	ARANDELA ELÁSTICA	
	227	902102 26600	ACOPLAMIENTO DE MOTOR	
	228	902227 00000	DISCO DE ACOPLAMIENTO	
	229	068004 26600	PIEZA DISTANCIADORA	
	231	946962 00000	ESPÁRRAGO	
	233	947109 00000	TUERCA HEXAGONAL	
	234	947509 00000	ARANDELA	
	236	961710 00000	ÁNGULO	
	237	972308 00000	ATORNILLADURA ERMETO	
	239	512200 26600	CONDUCTO DE RETROALIMENTACIÓN DE ACEITE	
	241	012204 26700	CONDUCTO	
	243	761703 01000	ATORNILLADURA ERMETO	
	244	012206 26600	CONDUCTO	
	245	012207 26600	CONDUCTO	
	247	961709 00000	ÁNGULO	
	248	064101 57000	GOMA PERFILADA	
	251	009400 19000	TORNILLO DE PIEZA ESFÉRICA	
	255	518300 26600	CAPERUZA	
	256	945389 00000	TORNILLO HEXAGONAL INTERIOR	
	281	768704 99626	VÁLVULA DE LASTRE DE GAS - OPCIONAL	
	282	740001 05000	CARTUCHO DE FILTRO, F10	
	290	060900 26600	ESTERA DE AMORTIGUADOR	
	291	943400 90000	SENSOR DE TEMPERATURA	
		960009 00200	BECKER LUBE M 100 (ACEITE MINERAL) - 5L	
		960016 00200	BECKER LUBE S 100 (ACEITE SINTÉTICO) - 5L	
		960023 00200	BECKER LUBE SL 100 (SECTOR ALIMENTARIO) - 5L	

¹⁾ Junta completa - 5549000 26700 - Pos.: 15, 16, 25, 31, 32, 40, 73, 87, 88, 101, 106, 109, 118, 124, 127, 141, 185, 191, 252, 254

²⁾ cantidad necesario / mantenimiento

U 4.400	Variante 	Pos. ²⁾	Bestell Nr. / Ident No. / No. Identification / No. Identificazione / No. De pedido		Beschreibung / Description / Designation / Designazione / Desripcion
① U 4.400 F/K		78	030701 26600		VENTILSCHEIBE / VALVE WASHER / TETE DE SOUPAPE / DISCO DELLA VALVOLA / DISCO DE VÁLVULA
		179	030702 26600		VENTILSCHEIBE / VALVE WASHER / TETE DE SOUPAPE / DISCO DELLA VALVOLA / DISCO DE VÁLVULA
		180	016802 26600		SPANNSCHEIBE / CLAMPING DISC / DISQUE DE SERRAGE / DISCO DI FISSAGGIO / ARANDELA TENSORA
		181	033901 26600		VENTILPLATTE / VALVE PLATE / CLAPET / SUPPORTO VALVOLA / PLACA DE VÁLVULA
		182	928603 20000		DRUCKFEDER / PRESSURE SPRING / RESSORT DE PRESSION / MOLLA DELLA PRESSIONE / MUELLE DE COMPRESIÓN
		183	016800 26600		SPANNSCHEIBE / CLAMPING DISC / DISQUE DE SERRAGE / DISCO DI FISSAGGIO / ARANDELA TENSORA
		184	028501 26600		VENTILBOLZEN / VALVE BOLT / TIGE DE SOUPAPE / VALVOLA BULLONE / BULÓN DE VÁLVULA
		187	013300 26600		PRALLBLECH / BAFFLE / DÉFLECTEUR / DEFLETTORE / DEFLECTOR
		188	945330 00000		INNENSECHSKANTSCHRAUBE / SOCKET HEAD SCREW / VIS HEXAGONALE INTERNE / VITE ESAGONALE INTERNA / TORNILLO HEXAGONAL INTERIOR
② U 4.400 (USA) <small>(all variants, plus auxiliaries)</small>		34	007801 26600	007800 26600	GEWINDEFLANSCH / FLANGE / BRIDE / FLANGIA / BRIDA ROSCADA
		105	002503 26600	002500 26600	ÖLABSCHEIDERDECKEL / OIL SEPARATOR COVER / COUVERCLE DE SEPARATEUR D'HUILE / COPERCHIO SEPARAZIONE OLIO / TAPA DE SEPARADOR DE ACEITE
		227	902103 26600	902102 26600	MOTORKUPPLUNG / COUPLING MOTORSIDE / ACCOUPLEMENT MOTEUR / GUINTO MOTORE / ACOPLAMIENTO DE MOTOR
		229	068093 26600	068004 26600	DISTANZSTÜCK / SPACER BLOCK / PIECE D'ECARTEMENT / DISTANZIATORE / PIEZA DISTANCIADORA
		295	037900 26600		ZWISCHENFLANSCH / FLANGE / BRIDE / FLANGIA / BRIDA INTERMEDIA
③ U 4.400 SA/K-25 ④ U 4.400 F/K-25 <small>- mit Öl-Wasser-Kühler - with oil-to-water heat exchanger - avec réfrigérant à l'huile et à l'eau - con radiatore ad olio - acqua - con refrigerador aceite-agua</small>		72	002403 26600	002402 26600	ÖLABSCHEIDERGEHÄUSE / HOUSING FOR OIL SEPARATION / CORP DE SEPARATEUR D'HUILE / CARCASSA SEPARAZIONE OLIO / CARCASA DE SEPARADOR DE ACEITE
		116	012400 26600		ZWISCHENSTÜCK / INTERMEDIATE PIECE / BRIDE / FLANGE / PIEZA INTERMEDIA
		121	560202 26600		KÜHLER / COOLER / REFROIDISSEUR / RAFFREDDATORE / REFRIGERADOR
		125	948029 00000		KUPFERRING / SEALING RING / JOINT / ANELLO / ANILLO DE COBRE
⑤ U 4.400 SA/K-51 ⑥ U 4.400 F/K-51 <small>- mit Ölbadheizung, Niveau-Geber und Thermostat - with oil bath heating, level transmitter and heat valve - avec chauffage du bain d'huile, capteur de niveau et thermostat - con riscaldamento a bagno d'olio, indicatore di livello e termostato - con calefacción de baño de aceite, codificador de nivel y termostato</small>		72	002403 26600	002402 26600	ÖLABSCHEIDERGEHÄUSE / HOUSING FOR OIL SEPARATION / CORP DE SEPARATEUR D'HUILE / CARCASSA SEPARAZIONE OLIO / CARCASA DE SEPARADOR DE ACEITE
		121	560201 26600		ROHRHEIZKÖRPER / PIPE HEATER / CORPS DE CHAUFFE / SCALDIGLIA / CALEFACTOR TUBULAR
		129	943400 70000		TEMPERATURWÄCHTER / THERMOSTAT / THERMOSTAT / INTERRUPTORE TERMICO / TERMOSTATO
		130	300300 07000		REDUZIER-NIPPEL / REDUCING BUSHES / MAMELONS REDUITS / RACCORDO DI RIDUZIONE / BOQUILLA DE REDUCCIÓN
		133		954224 00400	VERSCHLUSS-SCHRAUBE / SCREW PLUG / BOUCHON / VITE DI CHIUSURA / TORNILLO DE CIERRE
		134	741103 99682		NIVEAUGEBER / LEVEL TRANSMITTER / CAPTEUR DE NIVEAU / INDICATORE DI LIVELLO / CODIFICADOR DE NIVEL

²⁾ variantenabhängige Bauteile / variant-dependent components / composants variante-dependantes / componenti variante-dispendenti / componentes variante-dependientes