



SPECIFICATIONS

- Current rating: 7A AC/DC
- Voltage rating: 250V AC/DC
- Withstanding Voltage: 1500V AC/minute
- Insulation resistance: 1000MΩ Min
- Temperature range: -40°C~+105°C
- Compliant with RoHS and REACH

HOUSING

- Part NO.: AH1562-xP
- Suitable: AT1562T series Terminal
- Mates with: AW1562 series Wafer
- Material: Nylon 66, UL94V-0
- Color: White

Ordering Information & Dimensions:

Poles	Part No.	Dimensions(mm)	
		A	B
01	AH1562-01P	—	9.60
02	AH1562-02P	7.50	16.00
03	AH1562-03P	12.50	21.80
04	AH1562-04P	17.50	26.80
05	AH1562-05P	22.50	31.80
06	AH1562-06P	27.50	36.80

Unit:mm

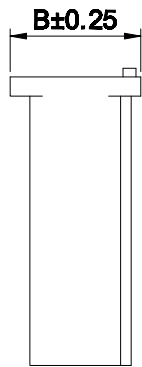
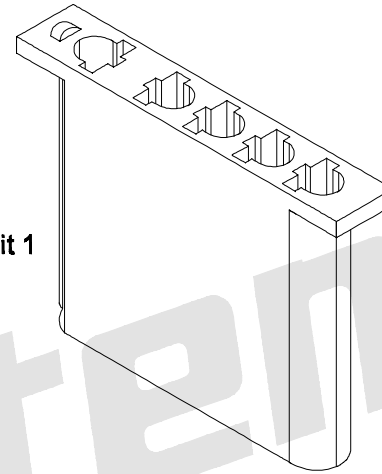
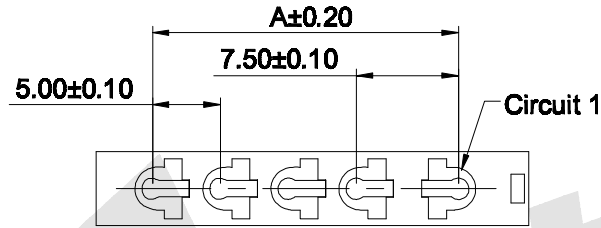
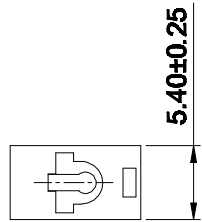

1P

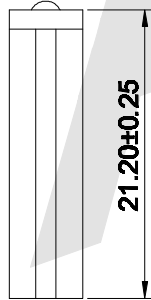

2~6P

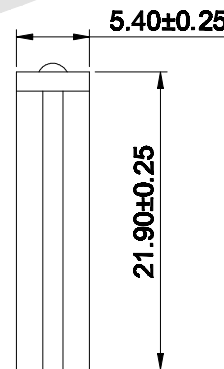
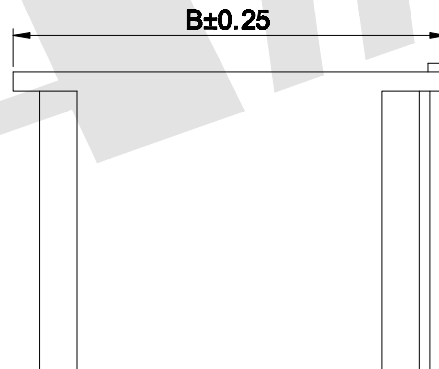

Unless Otherwise specified tolerance
 I: ±0.35 I, XX: ±0.20
 I, X: ±0.25 I, XXX: ±0.15

SCALE: As Shown UNIT: mm
 DRAW: Jack Bao DATE: 12/15/2017
 CHECK: Bob Yang DATE: 12/15/2017



Antenk ANTENK ELECTRONICS CO., LTD
[Http://www.antenk.com](http://www.antenk.com)
 E-mail: sales@antenk.com

TITLE: 7.50-5.00mm pitch Housing Connector Series

DRAWING NO: AH1562-xP

PRODUCT NO: AH1562-xP

REV	DESCRIPTION	DATE
1		
2		
3		
4		
5		