

HSF



SPECIFICATION

Current Rating: 3.0Amp
 Insulation Resistance: 1000MΩ min
 Contact Resistance: 20MΩ max
 Withstand Voltage: 500V AC/DC
 Operating Temperature: -40°C to +105°C
 Contact Material: Brass
 Contact Plating: Au or Sn Over Ni
 Insulator Material: PBT UL 94V-0

10~16 Pin Without "A"

Ordering Code:

BHD102 - X - X - X - X - X
 ① ② ③ ④ ⑤ ⑥

- ① Series No:
- ② No.of Contacts
6 8 10 12
14 16 18 20
24 26 30 34
40 50 60 64
- ③ Contact Plating:
G0:Gold flash S0>Selective
G1:3U" Gold S1>Selective 3u"
G2:5u" Gold S2>Selective 5u"
G3:10u" Gold S3>Selective 10u"
G4:15u" Gold S4>Selective 15u"
G5:30u" Gold S5>Selective 30u"
SN:Tin
- ④ Color Insulator
B:Black
U:Blue
G:Gray
- ⑤ Insulator Material
A:PBT
B:PA6T
C:LCP
- ⑥ Packing
A:Tray
B:Bag
T:Tube

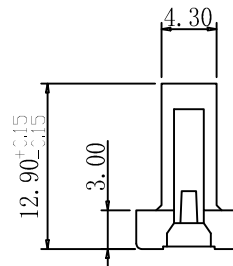
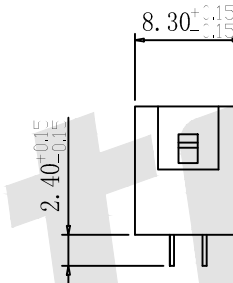
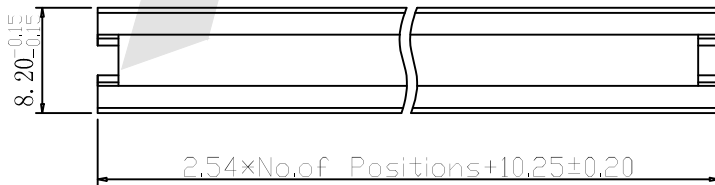
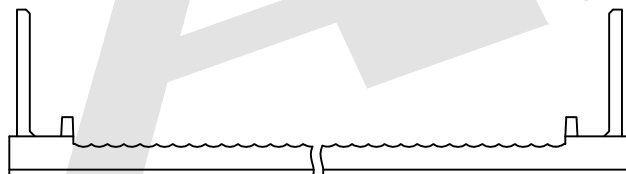
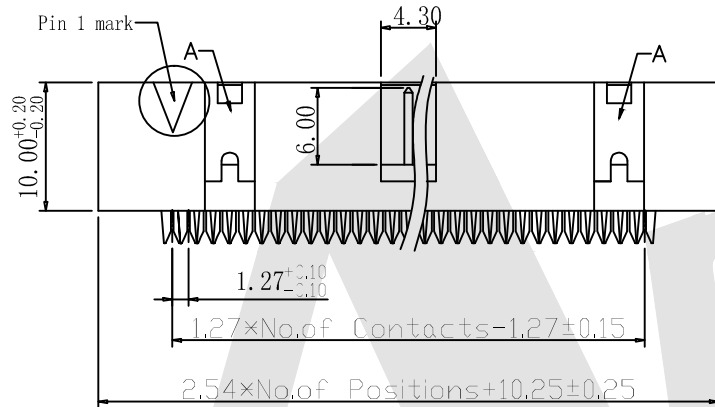
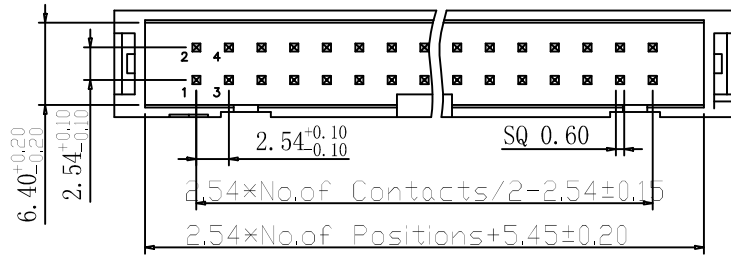

Unless Otherwise specified tolerance
 X. ±0.35 X.XX: ±0.20
 X.X: ±0.25 X.XXX: ±0.15

SCALE: As Shown UNIT: mm
 DRAW YG ZHONG DATE 01/05/2016
 CHECK BobYang DATE 01/05/2016

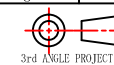

Antenk ANTENK ELECTRONICS CO.,LTD
 Http://www.antenk.com
 E-mail:sales@antenk.com

TITLE: 2.54mm Box Header IDC Type Without Mounting Ears

DRAWING NO: BHD102-XXXXX

PRODUCT NO: BHD102-XXXXX

REV	DESCRIPTION	DATE