

HSF

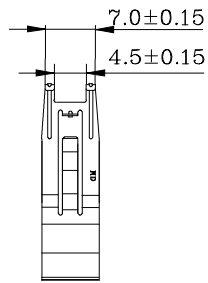

<HP - DB>

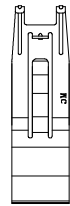
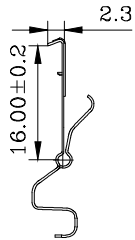

<HP - CN>

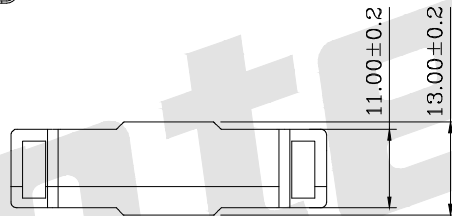
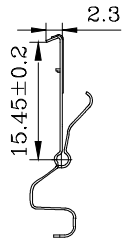

SPECIFICATIONS:

1. Material:

- 1.1 Back Shell: Zinc Plated Nickel Over Copper
- 1.2 Spring Latch: Stainless Steel
- 1.3 Flat Screw: Steel Nickel Plated Over Copper
- 1.4 Cable Clipper: Steel Nickel Plated Over Copper

Ordering Code:

HPMCS02 - 40 - 0 - S
 ① ② ③ ④

- ① Series No:
- ② Contact NO.: 40=40P
- ③ Entry Hole Sizes: 0=Close Type
- ④ Retention Features: S=Backshell selective Gold Plated

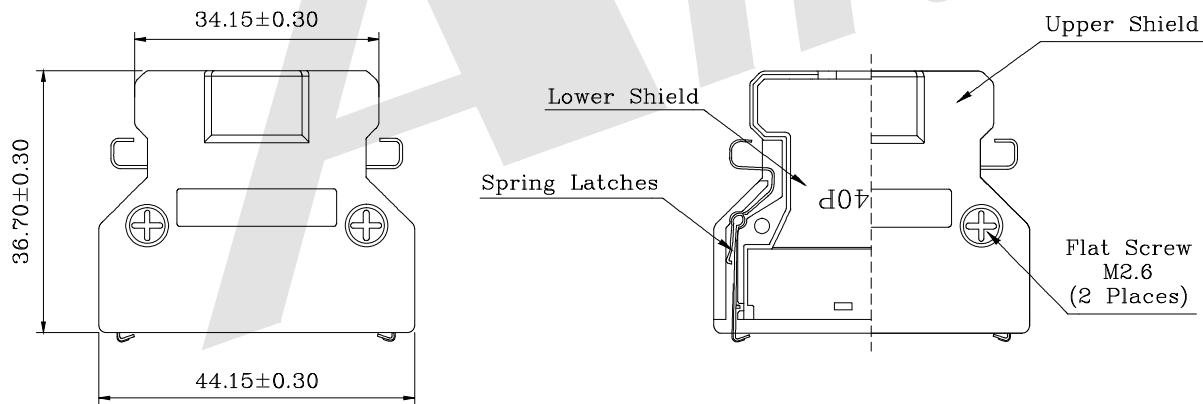

Unless Otherwise specified tolerance
 X. ±0.35 X.XX: ±0.20
 X.X: ±0.25 X.XXX: ±0.15

Antenk® ANTENK ELECTRONICS CO., LTD
[Http://www.antenk.com](http://www.antenk.com)
 E-mail:sales@antenk.com

SCALE: As Shown	UNIT: mm
DRAW Jack Bao	DATE 8/16/2018
CHECK Bob Yang	DATE 8/16/2018

TITLE: 1.27mm Series Shielded Backshell Kits 40P
 Straight Exit With Spring Latches

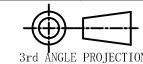

DRAWING NO:HPMCS02-400S
 PRODUCT NO:HPMCS02-400S

REV	DESCRIPTION	DATE